

# Stella

# SITS



*Cookes*

LIFE *well furnished*

# Stella

## UPHOLSTERY COMFORTS



fabric



STD standard

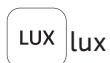

LUX lux



CLS classic

## COVERS



FC fixed

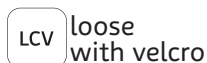

LCV loose with velcro

## SPECIAL



modular system

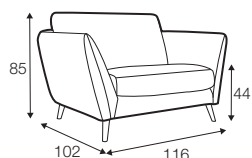

armchair

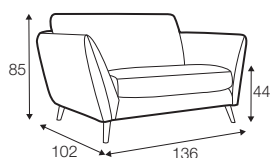

armchair wide

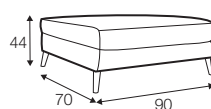

footstool 90x70

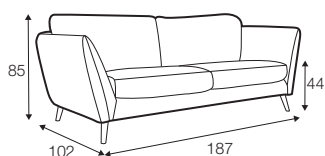

2 seater

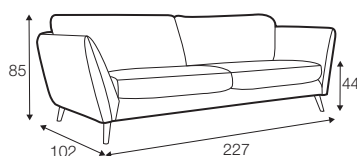

3 seater

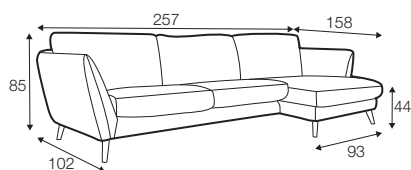

set 1 right / or left  
2 seater left / or right  
+ chaiselongue right / or left

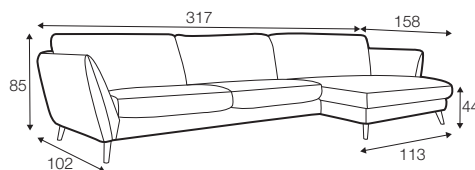

set 2 right / or left  
3 seater left / or right  
+ chaiselongue wide right / or left

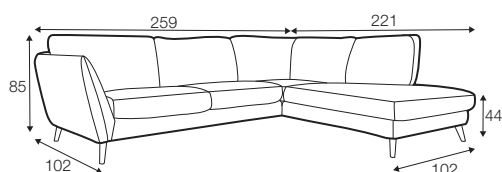

set 3 right / or left  
2 seater left / or right + divan right / or left

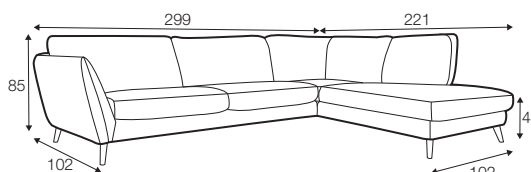

set 4 right / or left  
3 seater left / or right + divan right / or left

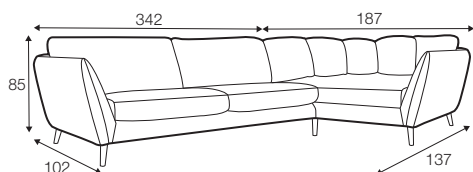

set 5 right / or left  
3 seater left / or right + cozy corner right / or left

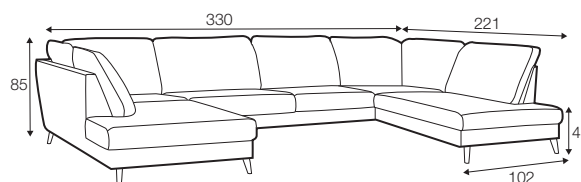

set 6  
divan left + 2 seater without armrests + divan right

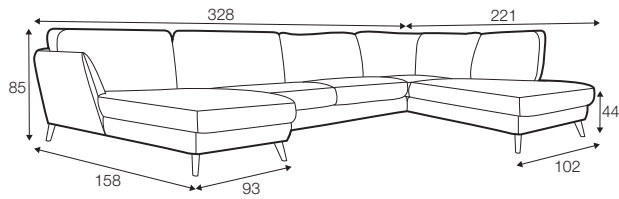

set 7 right / or left  
chaiselongue left / or right + 2 seater without armrests  
+ divan right / or left

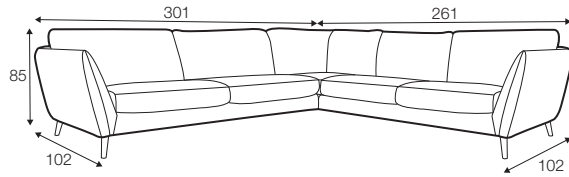

set 8 right / or left  
3 seater left / or right + corner 90° no. 1 + 2 seater right / or left

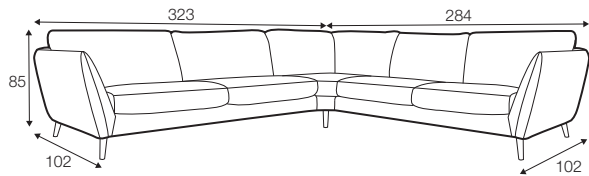

set 9 right / or left  
3 seater left / or right + corner 90° no. 2  
+ 2 seater right / or left

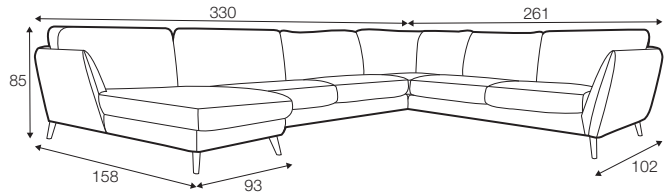

set 10 left / or right  
chaiselongue left / or right + 2 seater without armrests  
+ corner 90° no. 1 + 2 seater right / or left

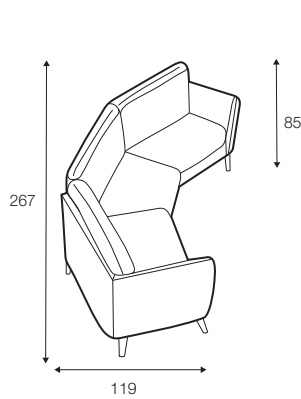

set 13  
armchair left + corner 30°  
+ armchair right

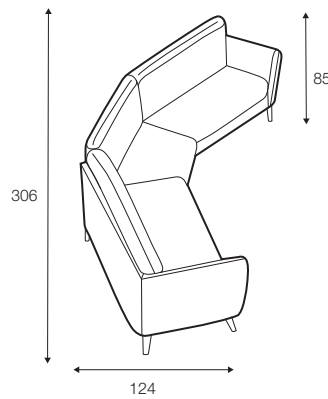

set 14  
armchair wide left + corner 30°  
+ armchair wide right

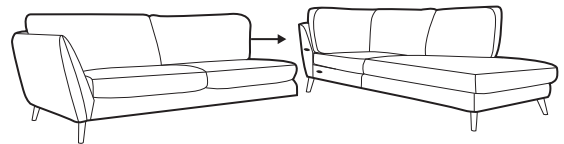

elements of the modular system

**modular system**

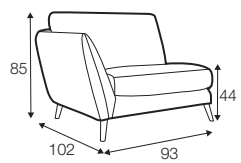

armchair left / or right

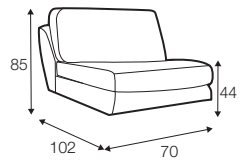

armchair  
without armrests

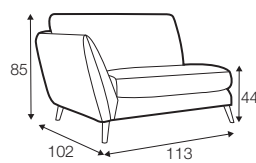

armchair wide left / or right

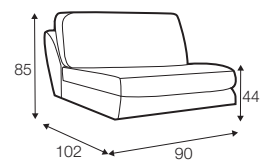

armchair wide  
without armrests

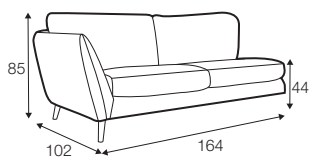

2 seater left / or right

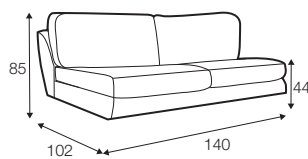

2 seater without armrests

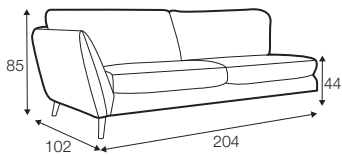

3 seater left / or right

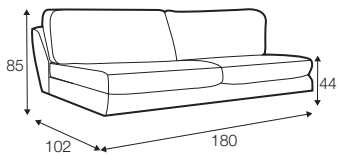

3 seater without armrests

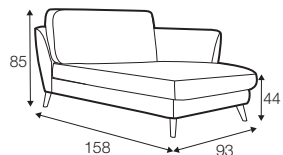

chaiselongue right / or left

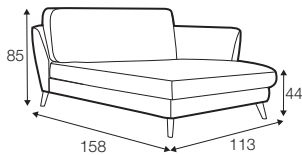

chaiselongue wide right / or left

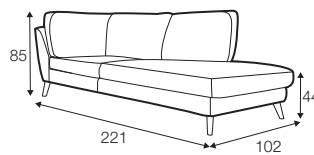

divan right / or left

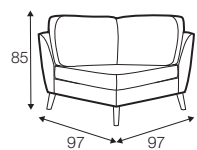

corner 90° no. 1

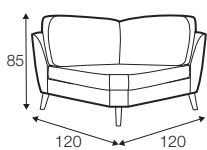

corner 90° no. 2

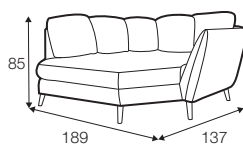

cozy corner right / or left

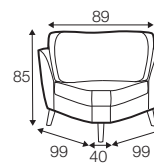

corner 30°

### extra dimensions

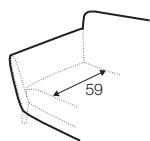

depth of seat

### accessories

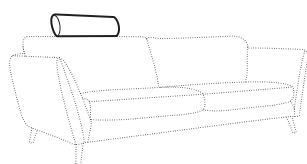

headrest L-62

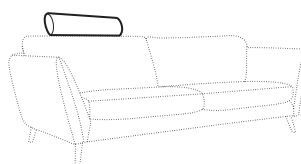
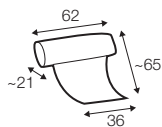

headrest L-77

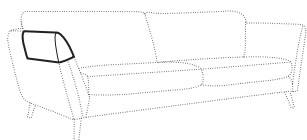
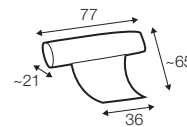

armrest protection



endpart left / or right

## legs

---

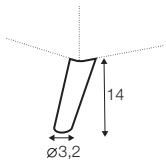

no. 141A  
wood  
recommended

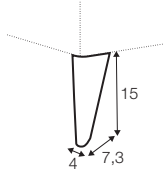

no. 91  
wood

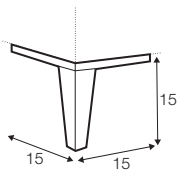

no. 152  
wood

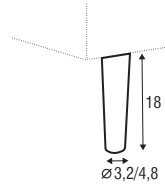

no. 141B  
wood

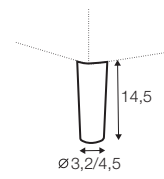

no. 153  
wood

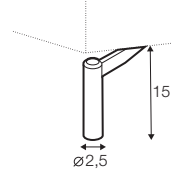

no. 145A  
metal chrome,  
painted black or grey  
and brushed steel\*

\*please check a cost of brushed steel finish with a sale representative.

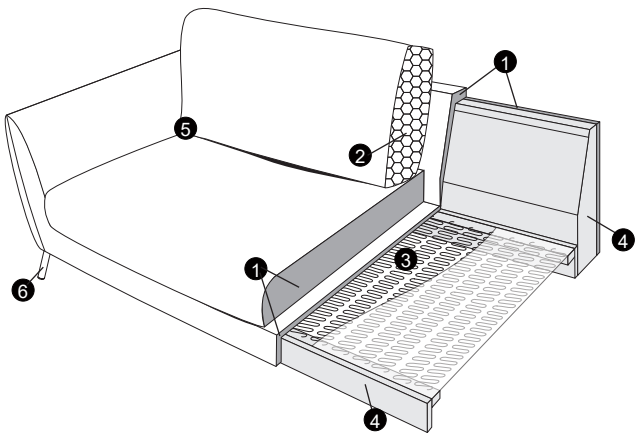

standard

1. polyurethane foam/high resilient polyurethane foam
2. silicone balls lux
3. springs
4. FSC® certified solid wood and wood based elements
5. fabric
6. FSC® certified solid wood or metal legs

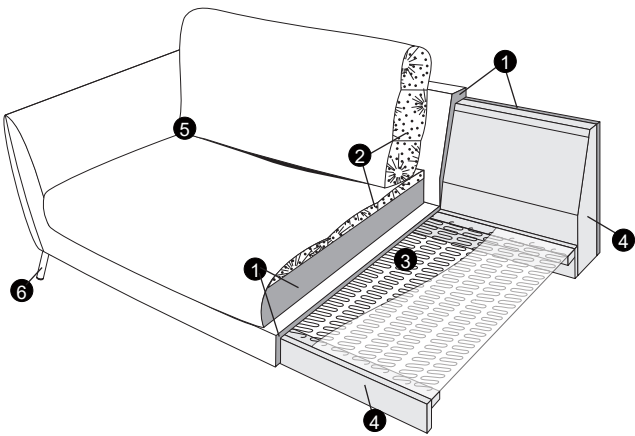

lux

1. polyurethane foam/ high resilient polyurethane foam
2. cushion chamber with mix of feather and silicone balls
3. springs
4. FSC® certified solid wood and wood based elements
5. fabric
6. FSC® certified solid wood or metal legs

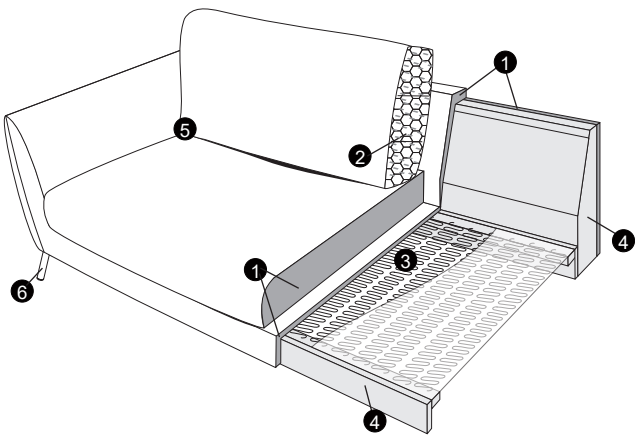

classic

1. polyurethane foam/high resilient polyurethane foam
2. silicone balls with foam sticks
3. springs
4. FSC® certified solid wood and wood based elements
5. fabric
6. FSC® certified solid wood or metal legs