

FUSION SERIES DINING TABLES



We are proud to say that Fusion dining table has won German Design Award Special 2021. The table has an elegant modern look with the metal legs and the elegant top in a boat shaped version. Fusion table takes an extension in each end, and the extensions can be stored under the large table.

Cookes | LIFE well furnished

Designed by
Morten Svendsen





FUSION table

No 735175 Main table

No 535049 1 x extension leaf 50 cm

Boat shaped dining table.
with possibility for extension
in each end. 4 - 6 seats -
extended 8- 10 seats.

Extension leaves to be ordered
separately.

L 175 W 95 H 75 cm.

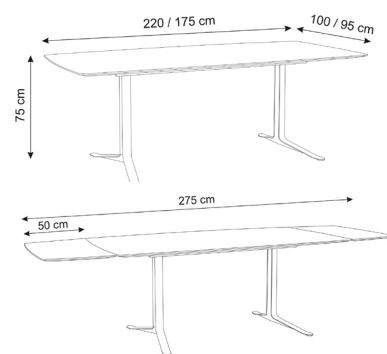

Fusion table

No 735220 Main table

No 535050 1 x extension leaf 50 cm

No 7386010 Storage for 2 ext.

Boat shaped dining table.
with possibility for extension
in each end. 6-8 seats
- extended 10-12 seats.
Magazine for ext. leaves can
be mounted under table

Extension leaves to be ordered
separately.

L 220 W 100 H 75 cm.

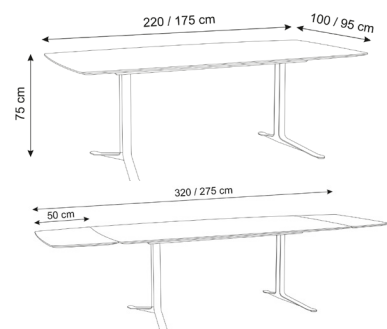







FUSION SERIES

Fusion table has an elegant modern look with metal legs and the elegant top in a boat shaped version. Fusion table takes an extension in each end, and the extensions can be stored in a magazine under the large table. You can choose design on the table by choosing your preferred surface and legs in either pure black metal legs or metal legs with veneer.





















COLOURS AND MATERIALS

BASE, EDGE

EDGE	 43 Light oak mat lac	 87 Black oak mat lac	 75 Walnut oil
LEGS	 Black metal w/ veneer 43 Light oak mat lac	 Black metal	 Black metal w/ veneer 75 Walnut oil

TABLETOP, DOORS AND DRAWERS

VENEER	 40 Light oak intarsia	 43 Light oak mat lac	 70 Walnut intarsia	 75 Walnut oil	
HPL LAMINAT	 101 White	 110 Seed	 128 Earth	 131 Storm	 184 Nero Stone
FENIX (NANO) LAMINATE	 201 Bianco White	 204 Deep Black	 210 Dark Warm Grey	 219 Verde	 222 Grigio
ARPA (MARBLE) LAMINATE	 301 Yule White	 302 Yule Grey	 303 Pulpis Light	 304 Pulpis Dark	

QUALITY FURNITURE SINCE 1968

PBJ Designhouse was founded in 1968 by Per Buhl Jørgensen. Since 1996 the proud design and craftsmanship tradition has been carried on by Morten Svendsen, and the company has invested in larger production facilities to follow the strong demand.

DANISH DESIGN

PBJ Designhouse has a tradition of bringing together furniture architects and certified cabinet makers since the start.

This has turned the company into an exponent of Denmark's proud traditions in furniture – when creativity and quality unite, the result reaches new heights.

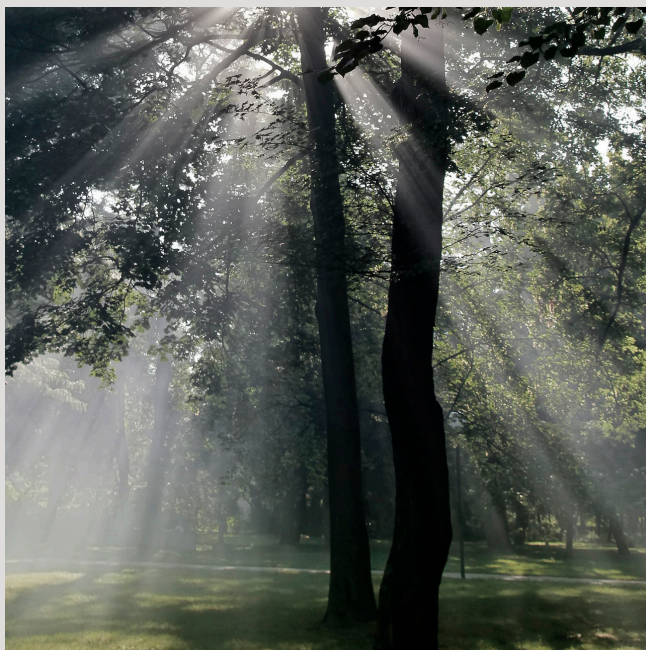

FURNITURE WITH A CONSCIENCE

All wood used at PBJ Designhouse comes from state approved plantations, where the logs are individually selected and gently harvested.

We often produce furniture with veneer. The reason for this is twofold. It reduces the use of solid timber, thereby conserving natural resources. Secondly, the MDF that the veneer cover is made with recycled wood which is better for the environment whilst still producing a strong and high-quality surface.

All of our timber and veneer are carefully hand sorted so that the grain patterns and color variations are as natural as possible.

The brochure is subject to technical changes and possible printing errors.

